



Your First Source For Innovative Interior Soffit Solutions & Custom Engineered Fabrications



The Ultimate Custom Enclosure System for Retrofit or New Construction Applications

UNIVERSITIES • COMMERCIAL • RESIDENTIAL • CORRECTIONAL

OUR INNOVATIVE SYSTEMS



Reliable & Appealing Soffit Systems for Exposed Pipe and Mechanicals

FM APPROVED AND UL/ULC LISTED

888.933.2248

www.JGIUS.com • sales@jgius.com

JG Innovations, Inc. is the #1 source for USA made steel soffit enclosure systems. Contributing to the industry for more than 30 years, we possess the expertise required to efficiently handle your unique pipe and mechanical enclosure requirements. Beginning with free design aid and competitive budgetary quotes, JG Innovations delivers the commitment necessary to take your next project from a conceptual design to reality. We take pride in our systems' design and integrity and are confident that you'll be fully satisfied.



CUSTOM FABRICATED • ANY SIZE, ANY DIMENSION, ANY SITUATION

PRODUCTS

Our full line of products are suitable for every concealment application, as they are manufactured to the dimensions you specify, are completely independent from your pipe or mechanical and can be used for both horizontal and vertical applications.

- The **Soffi-Steel® System** is produced from A60/G90 galvanized steel and possesses the unique **CON-SEAL-IT™** caulk retaining groove. The groove serves to feed and firmly retain the sealant along the length of the soffit/construction surface, ensuring a clean, tightly-sealed and **contraband-resistant** system. This reliable and simplistic enclosure is **FM Approved** as well as **UL/ULC Listed**.

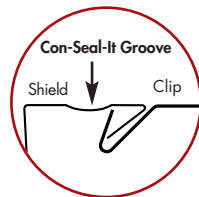

The Soffi-Steel® System

- The **Interlock™ Concealment System** is much the same as the **Soffi-Steel® System**, with a few design modifications for the purpose of even greater economy. **The Interlock™ Concealment System** is a more economical alternative to typical drywall applications and carries the **FM Approval**.

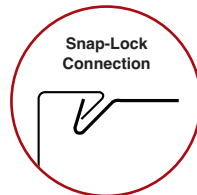

Interlock™ Concealment System

APPLICATIONS & USES

The **Soffi-Steel®** and **Interlock™ Concealment Systems** provide unequalled protection and security through an ingenious connecting system. **Virtually indestructible** and **tamper-resistant**, our custom fabricated enclosure systems are ideal for **commercial** and **institutional** applications and any other projects in which there are pressing security concerns. Our secure soffit systems provide industry professionals with extraordinary building products that will also satisfy many diverse construction requirements. The unique reverse curvature interfacing

between the 21 gauge chromium plated spring steel clips and the soffit cover renders the system irremovable once installed. If access to the pipes and mechanicals is desired, we can accommodate with access panels/doors.

The **Soffi-Steel®** and **Interlock™ Concealment Systems** have the adaptable capability to protect a myriad of utilities including fire protection, cable, piping, plumbing, HVAC and ductwork. While our custom fabricated enclosure systems are unsurpassed in retrofit applications, the flexible design makes it equally impressive for new construction projects. In addition, the **Soffi-Steel®** and **Interlock™ Concealment Systems** are Factory Mutual Approved for the protection of **BlazeMaster® Fire Sprinkler Pipe** and are UL and ULC Listed.



#1 SOURCE OF USA MADE STEEL SOFFIT SYSTEMS

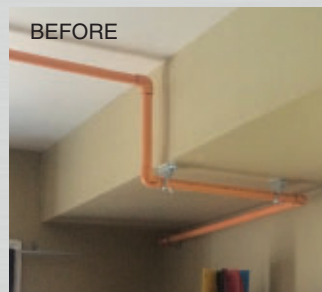
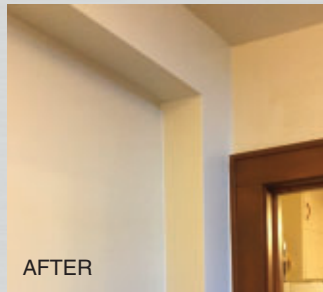

Utilize the **Soffi-Steel®** and **Interlock™ Concealment Systems** for applications in:

- Universities
- Nursing Homes
- Assisted Living Communities
- VA Hospitals and Clinics
- PK-12 Schools
- Residential Properties
- College Dormitories
- Student Housing
- Psychiatric Facilities
- Detention Centers
- Jails and Prisons
- Commercial Buildings

BENEFITS

Our **Soffi-Steel®** and **Interlock™ Concealment Systems** provide additional advantages beyond simply being enclosure solutions:

- **Diversity:** Available for light to heavy-duty applications
- **Flexibility:** Manufactured for your new construction or retrofit projects
- **Customization:** Completely fabricated to your exact specifications
- **Convenience:** Arriving within 3 weeks of ordering nationwide
- **Peace of Mind:** Backed by a 10-year limited warranty
- **Security:** Our soffit enclosure are virtually irremovable contraband resistant
- **Efficiency:** Requires few internal installation components
- **Appeal:** Supplies a streamlined, protective concealment method for exposed pipe and mechanicals

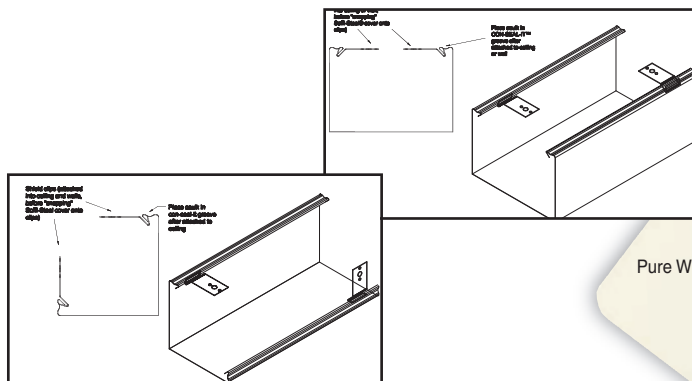

MATERIALS & FINISHES

The **Soffi-Steel®** and **Interlock™ Concealment Systems** are conveniently tailored to satisfy your individual project needs.

Our Soffi-Steel® and Interlock™ Concealment Systems are offered in:

- 304 Stainless Steel with a #4 finish: 16, 18, 20, 22 or 24 gauge.
- Zinc-galvanized Paintgrip (treated for field painting) with an A60 coating designation: 16, 18, 20, 22 or 24 gauge. As defined by standard specification ASTM A 653, A60 has a minimum coating weight of 183g/m2.
- .050 Aluminum

Several finish options to choose from:

- **Sherwin Williams** epoxy polyester hybrid powder coating provides a hard, durable, and attractive finish. Offered in Sherwin Williams Colors: Pure White, Dover White, Off White, Antique White and Custom Color options.



- Stainless Steel #4 Finish. Recommended in those instances which the shield may be exposed to extreme moisture.
- Primed with specific primer compatible with painting scheduled after installation.

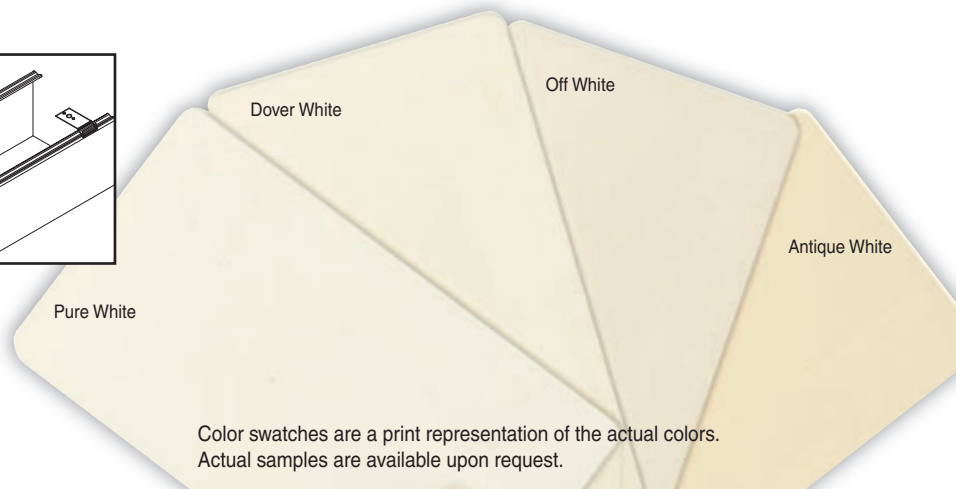

HEATING, AIR CONDITIONING & DOMESTIC WATER



Safely conceal your insulated or uninsulated line sets, hydronic piping, PVC, CPVC, steel pipe, copper pipe, drain lines or domestic plumbing supply lines with the **Soffi-Steel®** or **Interlock™ Concealment Systems**.

PROFILES: SIZE OF THE PIPE DOESN'T MATTER

Our pipe covers are manufactured in various profiles and virtually unlimited dimensions. Regardless of what your pipe diameter is or where your pipe is located, we've got you covered.

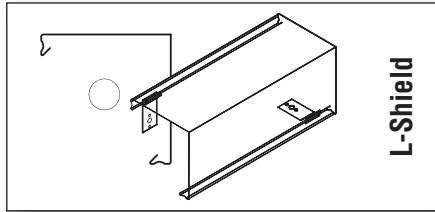

The **L-Shield** is primarily used for horizontal installations at the wall/floor, wall/ceiling or vertically in the corner at the floor to ceiling line when two sides of your pipe need to be covered.

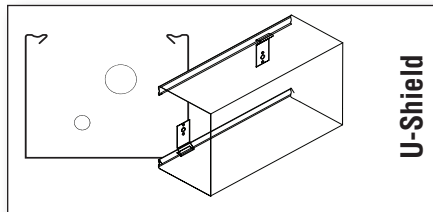

The **U-Shield** profile is used in the event that three sides of your pipe or mechanical needs to be covered both horizontally or vertically on walls or ceilings.

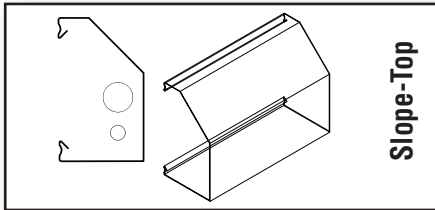

The **Slope-Top** profile is most commonly used in horizontal applications. The low profile is typically selected for aesthetics, discourages the use as a storage or sitting area and prevents the accumulation of dust and debris.

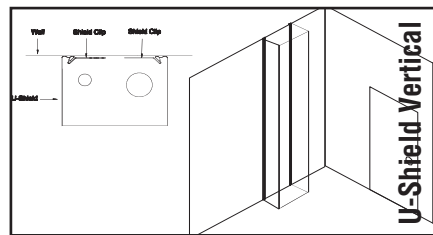
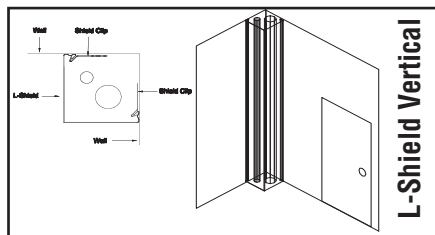

P.O. Box 8128 • Janesville, WI 53547
P: 608.314.8710 • **F:** 608.314.8712
TF: 888.933.2248 • **E:** sales@jgius.com

www.JGIUS.com

Exclusive Manufacturer of The Soffi-Steel®, JGI Interlock™ and AlumAFit™ Concealment Systems

Patent # 5,526,617 • Others Pending

ASSEMBLY & INSTALLATION

The **Soffi-Steel®** and **Interlock™ Concealment Systems** are as simplistic as they are flexible to install! Employment of minimal internal components such as spring steel shield clips, wall flanges, internal couplings and end caps provide an uncomplicated installation process. Designed to be convenient and effective enclosure systems, the **Soffi-Steel®** and **Interlock™ Concealment Systems** save you time and money, as installation can be completed by a non-specialized sub-contractor with common tools.

Providing a secure, streamlined cover shield for your facility's exposed mechanicals is a simplistic endeavor. Basic installation entails snapping the soffit cover material onto previously installed heavy-gauge spring steel shield clips. Individual lengths are then joined at each seam with an internal coupling system. Next, if required by the application, rivets can be used if the substrate is less than desirable to align the soffit sections. Lastly, sealant is applied to existing voids resulting from construction surface irregularities.

INSTALLATION SERVICES

JG Innovations, Inc. has a staff of professional experienced installation team working nationwide. We will be happy to quote your concealment project on a complete turnkey basis.

View a video of our installation process at

www.jgius.com/installation-support

CUSTOM QUICK SPEC

Create a customized specification on our website at www.jgius.com/specs



10-Year Limited Warranty

JG Innovations, Inc. warrants that products are free of material and workmanship defects for a period of ten (10) years from the delivery date of the products and that any defective products will be replaced without charge by JG Innovations, Inc. provided JG Innovations, Inc. and/or their authorized agent is given the prior opportunity to inspect any alleged defect and to examine the installation and use thereof. Except as set forth herein, JG Innovations, Inc. makes no representation or warranties, express or implied, of any kind or nature, including, but not limited to, any representation or warranties that JG Innovations, Inc. products are merchantable or fit for any particular purpose. The warranty set forth does not apply to and under no circumstances will JG Innovations, Inc. be liable for, any incidental, indirect, special, or consequential damage, loss, penalty or expense of any kind, including, but not limited to, any expense incurred for product removal or reinstallation. JG Innovations, Inc. will not be liable for any damage to or defect in any JG Innovations, Inc. product which has been subject to misuse, neglect or accident or which has been stored, used or installed in violation of recommended installation or maintenance procedures. (Patents pending.)

JJMER1016